

ambition



Desking programme





The basis for any concept, any project scenario and any organisation format. Future-oriented and flexible.

Wherever you're heading.



sira leg frame
Examples on pages 6-11



viva leg frame
Examples on pages 12-13



lima leg frame
Examples on pages 14-17



zena leg frame
Examples on pages 18-21



The supporting rail system underframe then creates the opportunity for multiple configuration possibilities, for desk extensions and for the fitting of accessories.

As you wish.



Decision-makers need a clear picture of how they want things to be. This also applies to the place where the decision is ultimately taken: clarity is the measure of all things.

sira leg frame in white aluminium with relief panel, desktop in black ash.



Taking decisions.





Enabling versatility.



Confirmation mail. Conference call. Like most companies you will probably have a point of convergence for all the activities that you have to handle simultaneously. So it's all the more important that you get the best possible support from your workstation.

sira leg frame in white aluminium, desktop in maple.



Practical by conviction. Convincing practicality. And always exactly where customers need them. It's good to know there really is furniture that makes this come true.

sira leg frame in anthracite metallic with white aluminium panel, desktop in pear.

Corporate efficiency.





Some teams of two are self-sufficient. Others know how important external motivation can be: it helps people to collaborate even better than before. And that shows.

viva leg frame in white aluminium with perforated panel, desktop in arctic white.

Sustaining openness.





How successfully a meeting goes off depends on the setting. Formal, intimate, casual. This is where it helps to have furniture that can be varied to suit different situations.

*lima leg frame in white aluminium,
desktop in arctic white.*

Successful communication.





Letting you concentrate.



Not all teams need to communicate all of the time: sometimes you need peace and quiet to concentrate on your work. So it's ideal if you can retreat behind a shared storage unit.

lima leg frame in white aluminium, desktop in beech.



Bringing together expertise.



Sometimes the whole is more than just the sum of its individual parts. And sometimes even more again. When gifted people from different backgrounds sit round a table together, the only thing we can predict is that they will produce excellent results!

zena leg frame in white aluminium.



Demonstrating unity.



We are who we are because we are the way we are. When it comes to building corporate culture, entrepreneurs are more than happy to give a helping hand – for example with a furnishing programme that highlights the factors differentiating their enterprise.

zena leg frame in white aluminium with wooden panel, desktop in arctic white.



Whatever you want.



ambition storage unit programme

A programme that leaves nothing to be desired: maximum freedom of choice and plenty of scope for individual ideas. Functional and also state of the art. The storage system that gives you practical details in perfection.

ambition mobile pedestal programme

The ambition mobile pedestal programme is characterised by huge variety. Harmonising perfectly with the desking programme aesthetics, the mobile pedestals have highly versatile interiors that let users organise them to suit their individual requirements.



sira



Leg frame in white aluminium, height adjustable 680-820 mm

viva



Leg frame in white aluminium, height adjustable 680-820 mm

lima



Leg frame in anthracite metallic, height adjustable 680-760 mm

zena



Leg frame in white aluminium, height adjustable 680-760 mm



Leg frame in anthracite metallic, height adjustable 680-820 mm



Leg frame in anthracite metallic, height adjustable 680-820 mm, leg panel with line pattern



Leg frame in white aluminium, height adjustable 680-760 mm



with satinised glass panel



Leg frame in anthracite metallic, height adjustable 680-820 mm, white aluminium panel



Leg frame in anthracite metallic, height adjustable 680-820 mm, leg panel with square pattern



with wooden panel



Leg frame in white aluminium, height adjustable 680-820 mm, anthracite metallic panel



Leg frame in white aluminium, height adjustable 680-820 mm, leg panel with perforated pattern



Leg frame in white aluminium, height adjustable 680-820 mm, anthracite metallic relief panel



Leg frame in anthracite metallic, height adjustable 680-820 mm, leg panel with Facette pattern

Functions. Tops. Formats. Colours.

Desks

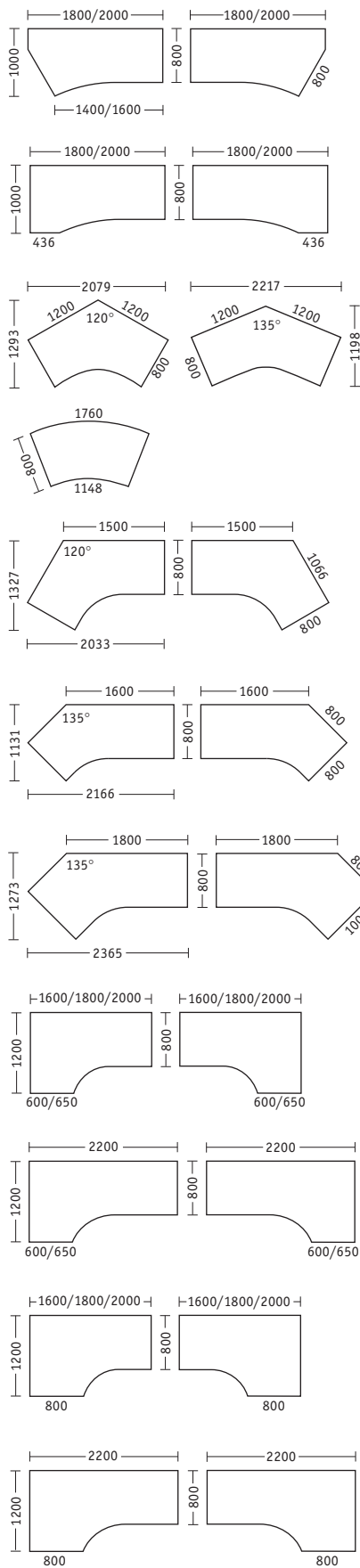
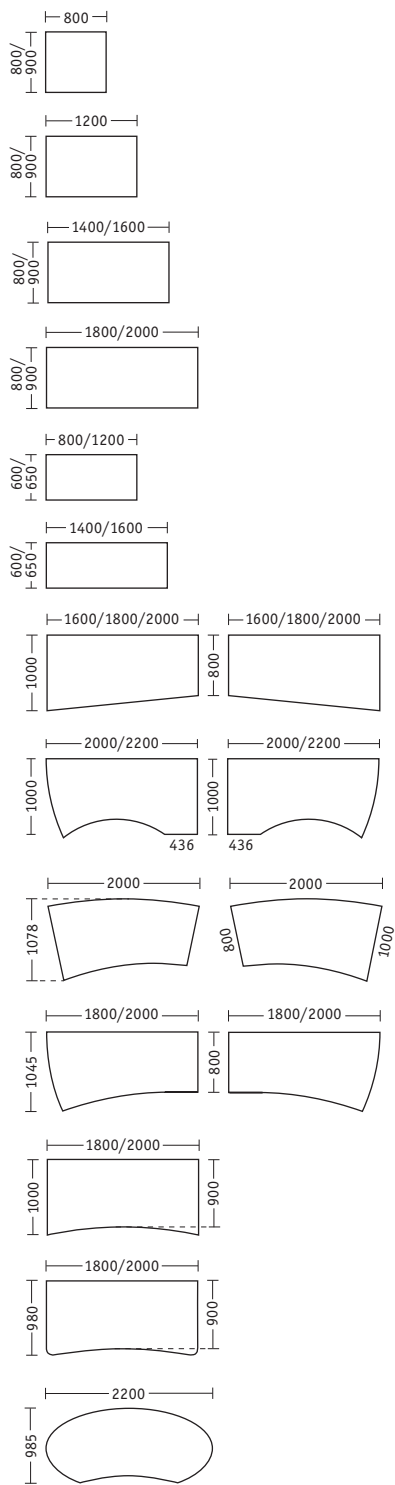

Linking and add-on elements

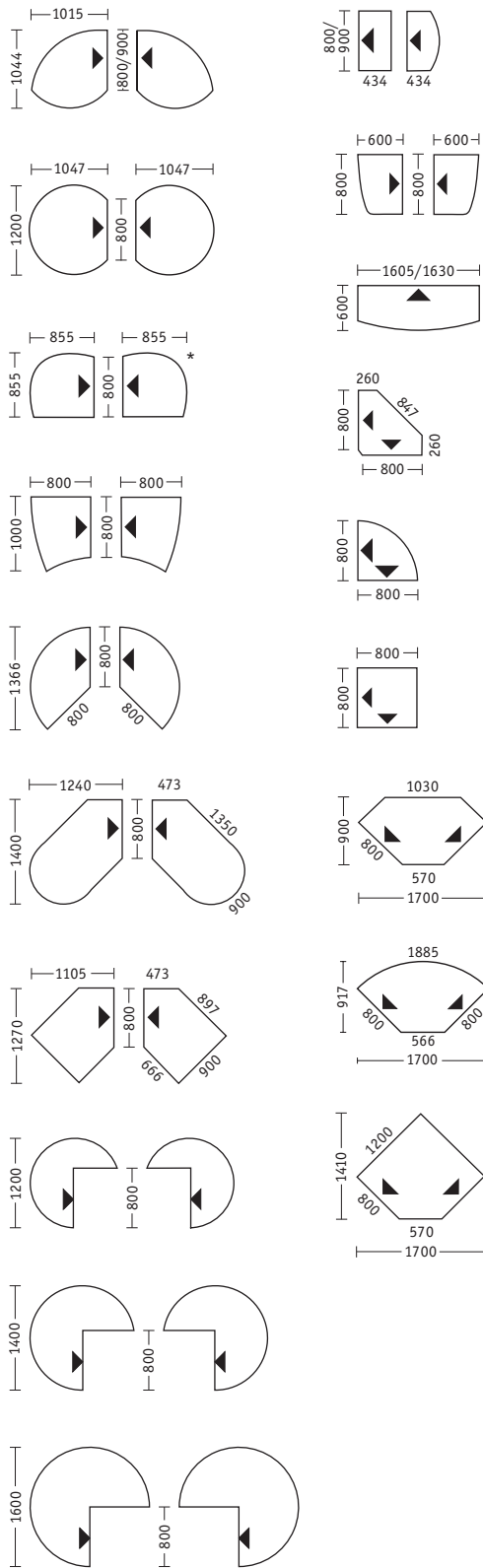

Conference tables

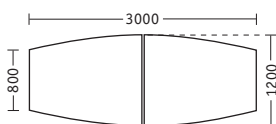
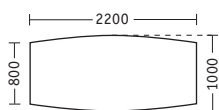
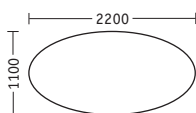
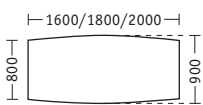
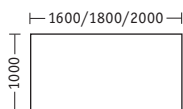
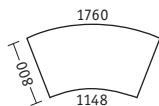
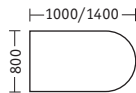
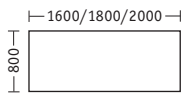
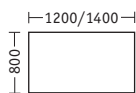

Lectern



Touchdown table



All the available desktop and leg frame combinations can be found in the current price list.

Dimensions (in mm), scale 1:100

◀ Linking edge

* Optional height adjustment

¹ only available for conference tables

Veneers



E10 Ash white



E46 Ash light grey



E45 Ash black



E41 Ash natural



C11 Oak natural



C17 Oak wenge varnish



B26 Beech natural



B21 Beech mid brown



B23 Beech walnut varnish



H11 Maple natural



D12 Walnut natural



D11 Walnut dark

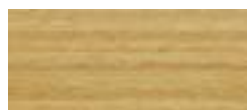

F31 Cherry natural



G11 Peartree natural

Melamine



203 Maple



103 Beech



K66 Walnut



K69 Acacia



A14 pure white ¹



02 arctic white



A16 dark grey ¹



K70 graphite black

Multiplex ABS-edge and Dual-colour edging



11 Beech



13 grey

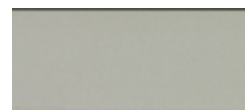

14 silver/black

Frame



119 white aluminium



09 anthrazit metallic



A force and form-integrated frame linking mechanism guarantees maximum stability



Side-mounted lectern with height adjustment function



Shelf/reception element for variable use



Freely positionable, fold-down cable tray

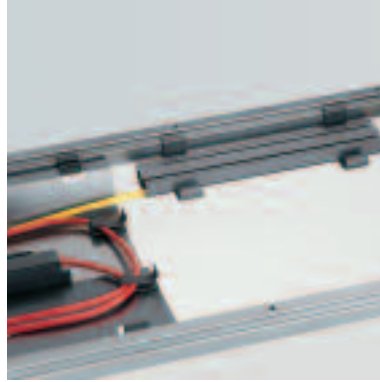

Cable channel for horizontal power supply



Integrated cable management for dual workstations



Vertiflex cable management system



Side-mounted printer shelf



Variable CPU holder, easily attached to the system rail



Freely positionable monitor shield, macro-perforated modesty panel



Tec-Reception unit with height-adjustable top shelf and perforated front panel

The lima and zena leg frames are also available with castors. Special features for the individual leg frames can be found in the current price list.



www.sedus.com